

ALPINESEMI™

beyond boundaries...

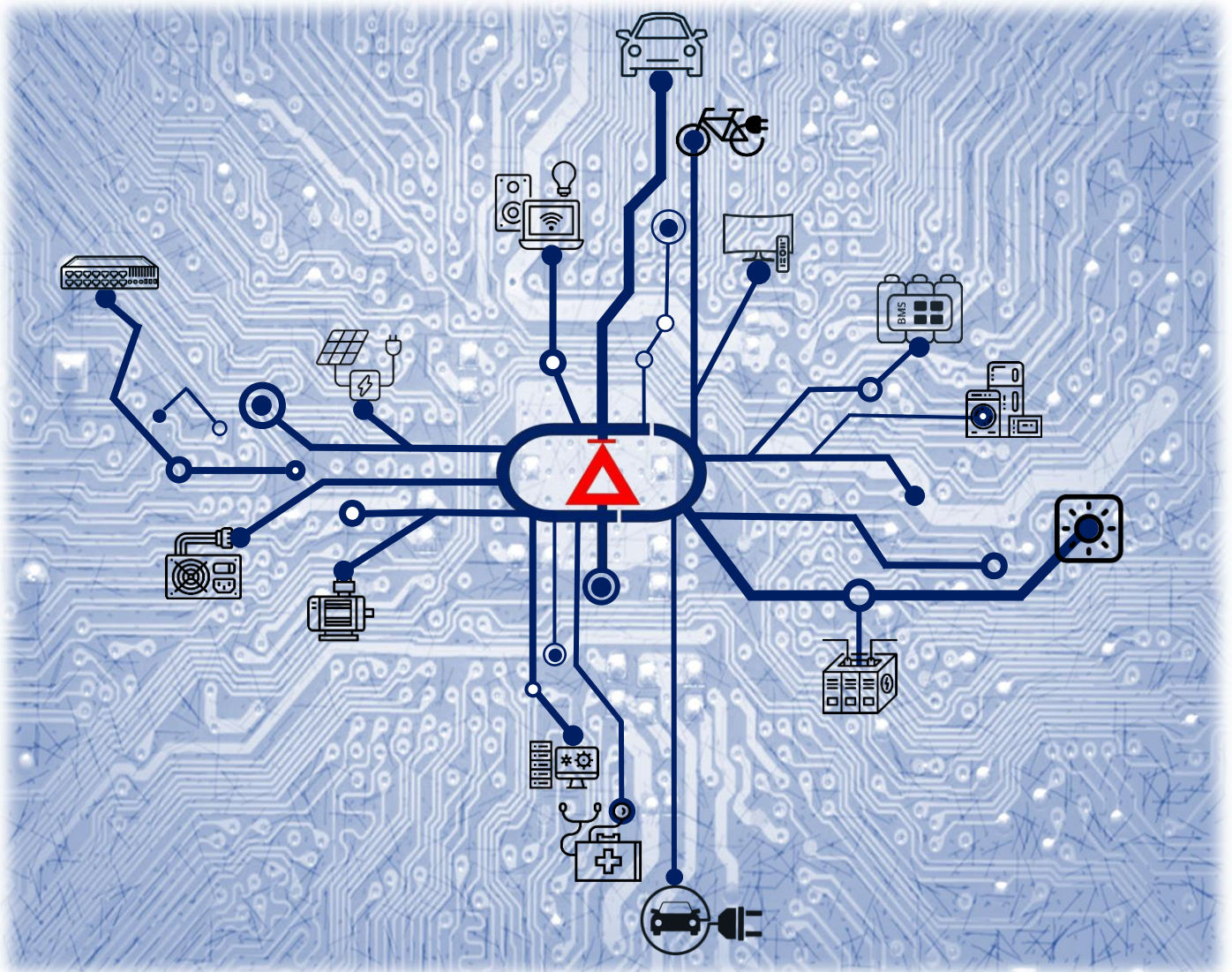

FAST RECOVERY RECTIFIERS

Short Form Catalogue

SMA

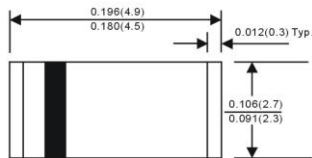

Dimensions in inches and (millimeters)

SMA-L

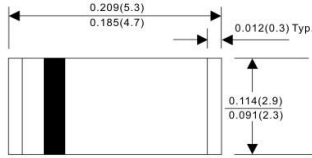

Dimensions in inches and (millimeters)

SMA-S

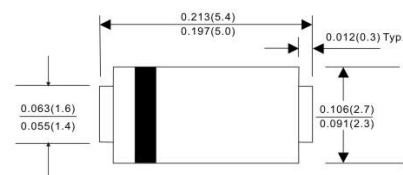

Dimensions in inches and (millimeters)

SMB-S

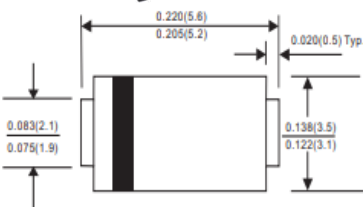

Dimensions in inches and (millimeters)

SMC

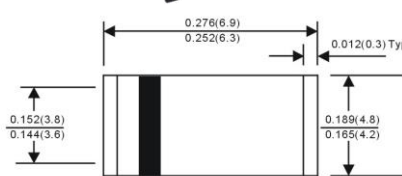

Dimensions in inches and (millimeters)

SOD-123

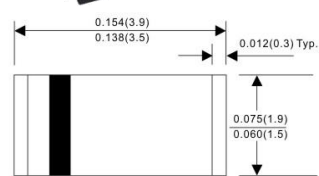

Dimensions in inches and (millimeters)

SOD-123H

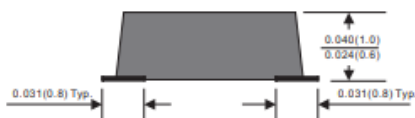
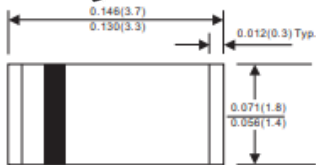

Dimensions in inches and (millimeters)

SOD-123S

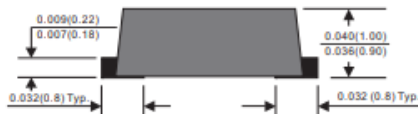
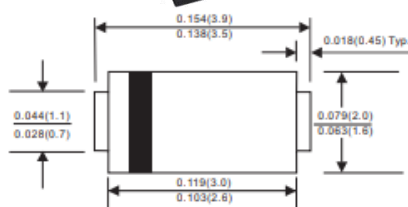

Dimensions in inches and (millimeters)

SOD-323

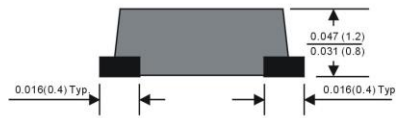
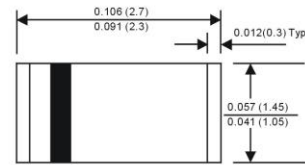

Dimensions in inches and (millimeters)

DO-15

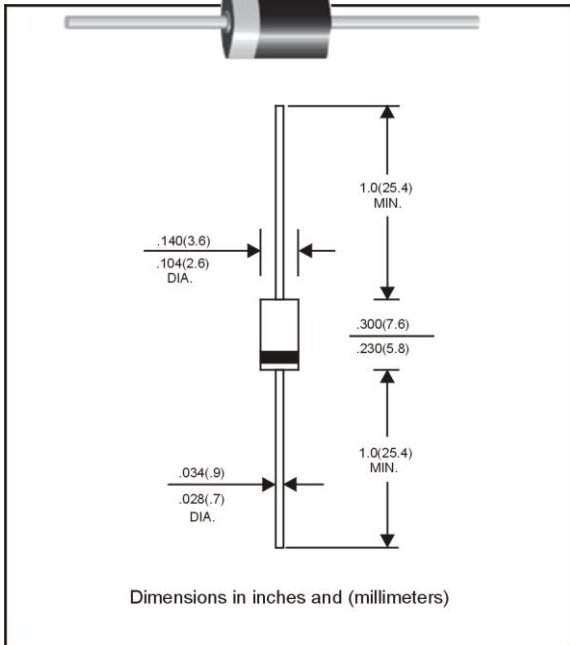

DO-201AD

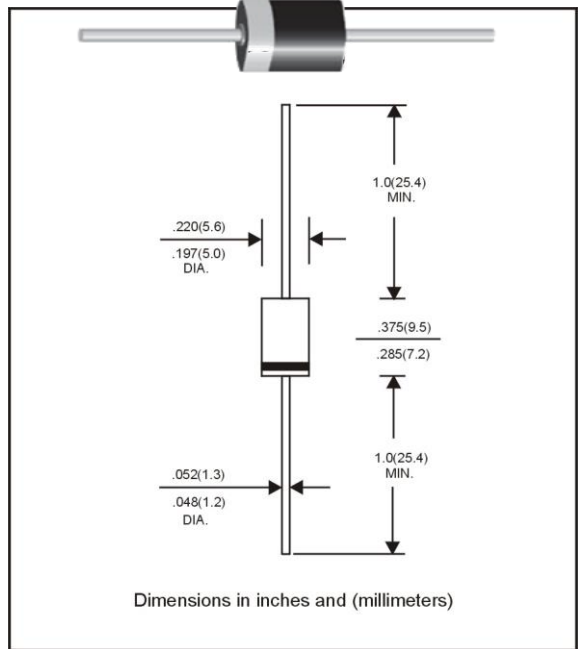

DO-41

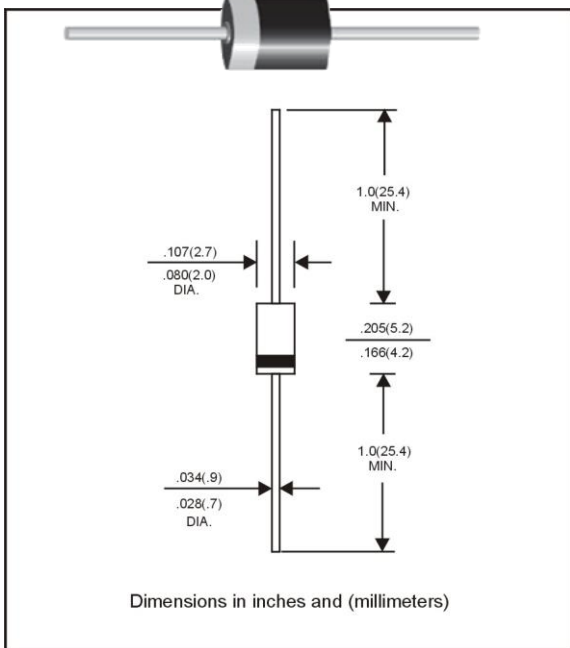

P600

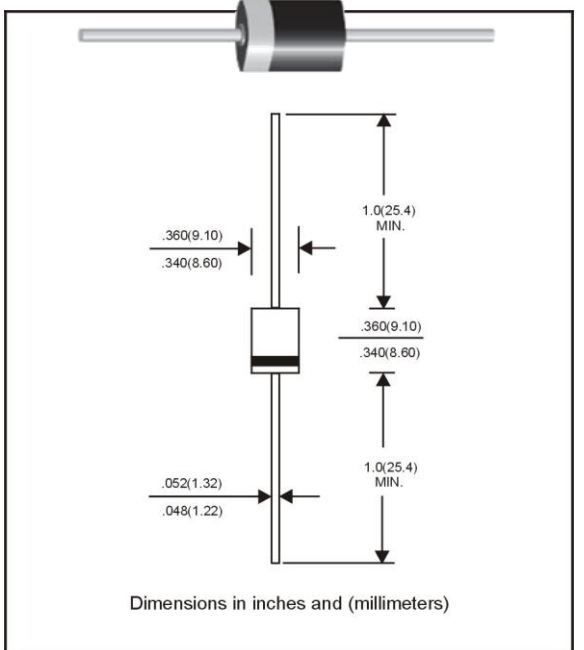

Alpinesemi™ Part Number	V _{RRM} (V)	I _{F(AV)} (A)	V _{F_MAX} (V)	I _{R_MAX} (μA)	t _{rr} (ns)	PACKAGE
ALP1N4933	50	1	1.2	5	120	DO-41
ALP1N4933G	50	1	1.2	5	120	DO-41
ALPFFM101	50	1	1.3	5	150	SMA
ALPFFM101-L	50	1	1.3	5	150	SMA-L
ALPFFM101-M	50	1	1.3	5	150	SOD-123
ALPFFM101-MH	50	1	1.3	5	150	SOD-123H
ALPFFM101-MS	50	1	1.3	5	150	SOD-123S
ALPFFM101-N	50	1	1.3	5	150	SOD-323
ALPFFM101-S	50	1	1.3	5	150	SMA-S
ALPFFM201	50	2	1.3	5	150	SMA
ALPFFM201-BS	50	2	1.3	5	150	SMB-S
ALPFFM201-L	50	2	1.3	5	150	SMA-L
ALPFFM201-S	50	2	1.3	5	150	SMA-S
ALPFFM301	50	3	1.3	5	150	SMC
ALPFFM301-BS	50	3	1.3	5	150	SMB-S
ALPFR101	50	1	1.3	5	150	DO-41
ALPFR101G	50	1	1.3	5	150	DO-41
ALPFR151	50	1.5	1.3	5	150	DO-15
ALPFR151G	50	1.5	1.3	5	150	DO-15
ALPFR201	50	2	1.3	5	150	DO-15
ALPFR201G	50	2	1.3	5	150	DO-15
ALPFR301	50	3	1.3	5	150	DO-201AD
ALPFR301G	50	3	1.3	5	150	DO-201AD
ALPFR601	50	6	1.3	5	150	P600
ALPFR601G	50	6	1.3	5	150	P600
ALP1N4934	100	1	1.2	5	120	DO-41
ALP1N4934G	100	1	1.2	5	120	DO-41
ALPFFM102	100	1	1.3	5	150	SMA
ALPFFM102-L	100	1	1.3	5	150	SMA-L
ALPFFM102-M	100	1	1.3	5	150	SOD-123
ALPFFM102-MH	100	1	1.3	5	150	SOD-123H
ALPFFM102-MS	100	1	1.3	5	150	SOD-123S
ALPFFM102-N	100	1	1.3	5	150	SOD-323
ALPFFM102-S	100	1	1.3	5	150	SMA-S
ALPFFM202	100	2	1.3	5	150	SMA
ALPFFM202-BS	100	2	1.3	5	150	SMB-S
ALPFFM202-L	100	2	1.3	5	150	SMA-L
ALPFFM202-S	100	2	1.3	5	150	SMA-S
ALPFFM302	100	3	1.3	5	150	SMC
ALPFFM302-BS	100	3	1.3	5	150	SMB-S
ALPFR102	100	1	1.3	5	150	DO-41
ALPFR102G	100	1	1.3	5	150	DO-41
ALPFR152	100	1.5	1.3	5	150	DO-15
ALPFR152G	100	1.5	1.3	5	150	DO-15

Alpinesemi™ Part Number	V _{RRM} (V)	I _{F(AV)} (A)	V _{F_MAX} (V)	I _{R_MAX} (μA)	t _{rr} (ns)	PACKAGE
ALPFR202	100	2	1.3	5	150	DO-15
ALPFR202G	100	2	1.3	5	150	DO-15
ALPFR302	100	3	1.3	5	150	DO-201AD
ALPFR302G	100	3	1.3	5	150	DO-201AD
ALPFR602	100	6	1.3	5	150	P600
ALPFR602G	100	6	1.3	5	150	P600
ALP1N4935	200	1	1.2	5	120	DO-41
ALP1N4935G	200	1	1.2	5	120	DO-41
ALPFFM103	200	1	1.3	5	150	SMA
ALPFFM103-L	200	1	1.3	5	150	SMA-L
ALPFFM103-M	200	1	1.3	5	150	SOD-123
ALPFFM103-MH	200	1	1.3	5	150	SOD-123H
ALPFFM103-MS	200	1	1.3	5	150	SOD-123S
ALPFFM103-N	200	1	1.3	5	150	SOD-323
ALPFFM103-S	200	1	1.3	5	150	SMA-S
ALPFFM203	200	2	1.3	5	150	SMA
ALPFFM203-BS	200	2	1.3	5	150	SMB-S
ALPFFM203-L	200	2	1.3	5	150	SMA-L
ALPFFM203-S	200	2	1.3	5	150	SMA-S
ALPFFM303	200	3	1.3	5	150	SMC
ALPFFM303-BS	200	3	1.3	5	150	SMB-S
ALPFR103	200	1	1.3	5	150	DO-41
ALPFR103G	200	1	1.3	5	150	DO-41
ALPFR153	200	1.5	1.3	5	150	DO-15
ALPFR153G	200	1.5	1.3	5	150	DO-15
ALPFR203	200	2	1.3	5	150	DO-15
ALPFR203G	200	2	1.3	5	150	DO-15
ALPFR303	200	3	1.3	5	150	DO-201AD
ALPFR303G	200	3	1.3	5	150	DO-201AD
ALPFR603	200	6	1.3	5	150	P600
ALPFR603G	200	6	1.3	5	150	P600
ALP1N4936	400	1	1.2	5	120	DO-41
ALP1N4936G	400	1	1.2	5	120	DO-41
ALPFFM104	400	1	1.3	5	150	SMA
ALPFFM104-L	400	1	1.3	5	150	SMA-L
ALPFFM104-M	400	1	1.3	5	150	SOD-123
ALPFFM104-MH	400	1	1.3	5	150	SOD-123H
ALPFFM104-MS	400	1	1.3	5	150	SOD-123S
ALPFFM104-N	400	1	1.3	5	150	SOD-323
ALPFFM104-S	400	1	1.3	5	150	SMA-S
ALPFFM204	400	2	1.3	5	150	SMA
ALPFFM204-BS	400	2	1.3	5	150	SMB-S
ALPFFM204-L	400	2	1.3	5	150	SMA-L
ALPFFM204-S	400	2	1.3	5	150	SMA-S

Alpinesemi™ Part Number	V _{RRM} (V)	I _{F(AV)} (A)	V _{F_MAX} (V)	I _{R_MAX} (μA)	t _{rr} (ns)	PACKAGE
ALPFFM304	400	3	1.3	5	150	SMC
ALPFFM304-BS	400	3	1.3	5	150	SMB-S
ALPFR104	400	1	1.3	5	150	DO-41
ALPFR104G	400	1	1.3	5	150	DO-41
ALPFR154	400	1.5	1.3	5	150	DO-15
ALPFR154G	400	1.5	1.3	5	150	DO-15
ALPFR204	400	2	1.3	5	150	DO-15
ALPFR204G	400	2	1.3	5	150	DO-15
ALPFR304	400	3	1.3	5	150	DO-201AD
ALPFR304G	400	3	1.3	5	150	DO-201AD
ALPFR604	400	6	1.3	5	150	P600
ALPFR604G	400	6	1.3	5	150	P600
ALP1N4937	600	1	1.2	5	120	DO-41
ALP1N4937G	600	1	1.2	5	120	DO-41
ALPFFM105	600	1	1.3	5	250	SMA
ALPFFM105-L	600	1	1.3	5	250	SMA-L
ALPFFM105-M	600	1	1.3	5	250	SOD-123
ALPFFM105-MH	600	1	1.3	5	250	SOD-123H
ALPFFM105-MS	600	1	1.3	5	250	SOD-123S
ALPFFM105-N	600	1	1.3	5	250	SOD-323
ALPFFM105-S	600	1	1.3	5	250	SMA-S
ALPFFM205	600	2	1.3	5	250	SMA
ALPFFM205-BS	600	2	1.3	5	250	SMB-S
ALPFFM205-L	600	2	1.3	5	250	SMA-L
ALPFFM205-S	600	2	1.3	5	250	SMA-S
ALPFFM305	600	3	1.3	5	250	SMC
ALPFFM305-BS	600	3	1.3	5	250	SMB-S
ALPFR105	600	1	1.3	5	250	DO-41
ALPFR105G	600	1	1.3	5	250	DO-41
ALPFR155	600	1.5	1.3	5	250	DO-15
ALPFR155G	600	1.5	1.3	5	250	DO-15
ALPFR205	600	2	1.3	5	250	DO-15
ALPFR205G	600	2	1.3	5	250	DO-15
ALPFR305	600	3	1.3	5	250	DO-201AD
ALPFR305G	600	3	1.3	5	250	DO-201AD
ALPFR605	600	6	1.3	5	250	P600
ALPFR605G	600	6	1.3	5	250	P600
ALPFFM106	800	1	1.3	5	500	SMA
ALPFFM106-L	800	1	1.3	5	500	SMA-L
ALPFFM106-M	800	1	1.3	5	500	SOD-123
ALPFFM106-MH	800	1	1.3	5	500	SOD-123H
ALPFFM106-MS	800	1	1.3	5	500	SOD-123S
ALPFFM106-N	800	1	1.3	5	500	SOD-323
ALPFFM106-S	800	1	1.3	5	500	SMA-S

Alpinesemi™ Part Number	V _{RRM} (V)	I _{F(AV)} (A)	V _{F_MAX} (V)	I _{R_MAX} (μA)	t _{rr} (ns)	PACKAGE
ALPFFM206	800	2	1.3	5	500	SMA
ALPFFM206-BS	800	2	1.3	5	500	SMB-S
ALPFFM206-L	800	2	1.3	5	500	SMA-L
ALPFFM206-S	800	2	1.3	5	500	SMA-S
ALPFFM306	800	3	1.3	5	500	SMC
ALPFFM306-BS	800	3	1.3	5	500	SMB-S
ALPFR106	800	1	1.3	5	500	DO-41
ALPFR106G	800	1	1.3	5	500	DO-41
ALPFR156	800	1.5	1.3	5	500	DO-15
ALPFR156G	800	1.5	1.3	5	500	DO-15
ALPFR206	800	2	1.3	5	500	DO-15
ALPFR206G	800	2	1.3	5	500	DO-15
ALPFR306	800	3	1.3	5	500	DO-201AD
ALPFR306G	800	3	1.3	5	500	DO-201AD
ALPFR606	800	6	1.3	5	500	P600
ALPFR606G	800	6	1.3	5	500	P600
ALPFFM107	1000	1	1.3	5	500	SMA
ALPFFM107-L	1000	1	1.3	5	500	SMA-L
ALPFFM107-M	1000	1	1.3	5	500	SOD-123
ALPFFM107-MH	1000	1	1.3	5	500	SOD-123H
ALPFFM107-MS	1000	1	1.3	5	500	SOD-123S
ALPFFM107-N	1000	1	1.3	5	500	SOD-323
ALPFFM107-S	1000	1	1.3	5	500	SMA-S
ALPFFM207	1000	2	1.3	5	500	SMA
ALPFFM207-BS	1000	2	1.3	5	500	SMB-S
ALPFFM207-L	1000	2	1.3	5	500	SMA-L
ALPFFM207-S	1000	2	1.3	5	500	SMA-S
ALPFFM307	1000	3	1.3	5	500	SMC
ALPFFM307-BS	1000	3	1.3	5	500	SMB-S
ALPFR107	1000	1	1.3	5	500	DO-41
ALPFR107G	1000	1	1.3	5	500	DO-41
ALPFR157	1000	1.5	1.3	5	500	DO-15
ALPFR157G	1000	1.5	1.3	5	500	DO-15
ALPFR207	1000	2	1.3	5	500	DO-15
ALPFR207G	1000	2	1.3	5	500	DO-15
ALPFR307	1000	3	1.3	5	500	DO-201AD
ALPFR307G	1000	3	1.3	5	500	DO-201AD
ALPFR607	1000	6	1.3	5	500	P600
ALPFR607G	1000	6	1.3	5	500	P600

DISCLAIMER

The product information and the selection guide facilitates the selection of the ALPINESEMI™'s Semiconductor Device(s) best suited for application in your product(s) as per your requirement. It is recommended that you completely review the Data sheet(s) so as to confirm that the Device(s) meets functionality parameters for your application. The information furnished on the Data Sheet and the ALPINESEMI™'s Web Site is believed to be accurate and reliable at the time of preparation of this document. ALPINESEMI™ however, does not assume any inaccuracies that may arise when the components are mounted and removed. Furthermore, ALPINESEMI™ does not assume liability whatsoever, arising out of the application or the use of any of ALPINESEMI™'s product(s). Neither, does it convey any license under its patent rights nor the rights of others. These products are not guaranteed for use in life saving/support appliances or systems. ALPINESEMI™'s customers using these products (either as individual Semiconductor Devices or incorporated in their end products), in any life saving/support appliances or systems or applications do so at their own risk and ALPINESEMI™ will not be responsible in any way(s) for any damage(s) resulting from such use.

Please check the website www.alpinesemi.com for continues updates and revision of datasheets.

DESIGN CHANGES: ALPINESEMI™ strives for continuous improvement and reserves the right to change the specifications of its products without prior notice. ALPINESEMI™ reserves the right to discontinue product lines without prior notice. Any product selection is a recommendation based on best understanding of such product(s) by our engineers. However, buyers are advised to rely on their own judgment for such selection of the products.

ALPINESEMI™ makes no warranty, representation or guarantee regarding the suitability of its products for any particular applications. Neither does ALPINESEMI™ assume any liability arising out of the applications nor the use of such products. ALPINESEMI™ specifically disclaims all liabilities either consequential or incidental.

All rights of the product and datasheet are reserved to ALPINESEMI™.

All logos and information provided in the datasheets are for reference only. Any registered and/or trademark/logos belonging to respective companies be the property of those companies. ALPINESEMI™ extends the courtesy to them, if any of the information found in its datasheet.

Component Disposal Instructions

1. ALPINESEMI™ Semiconductor Devices are RoHS compliant and hence customers are requested to dispose as per the prevailing Environmental Legislation put forth in their specific country.
2. In Europe, please dispose as per EU Directive 2002/96/EC on Waste Electrical and Electronic Equipment (WEEE).



ALPINESEMI

sales@alpinesemi.com

www.alpinesemi.com